

# STAFFE & ANGOLARI - BÜGEL UND VERANKERUNGSWINKELELEMENTE MOLDING BOXES & ANCHORING ANGLE BARS

A3

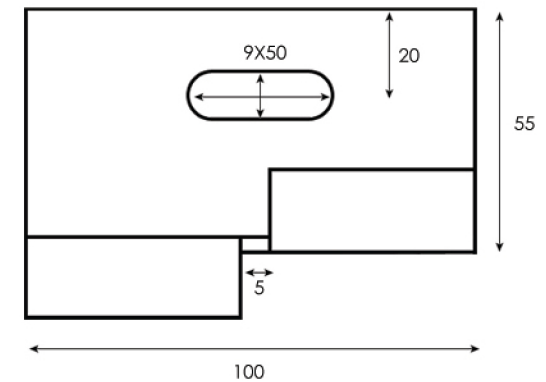
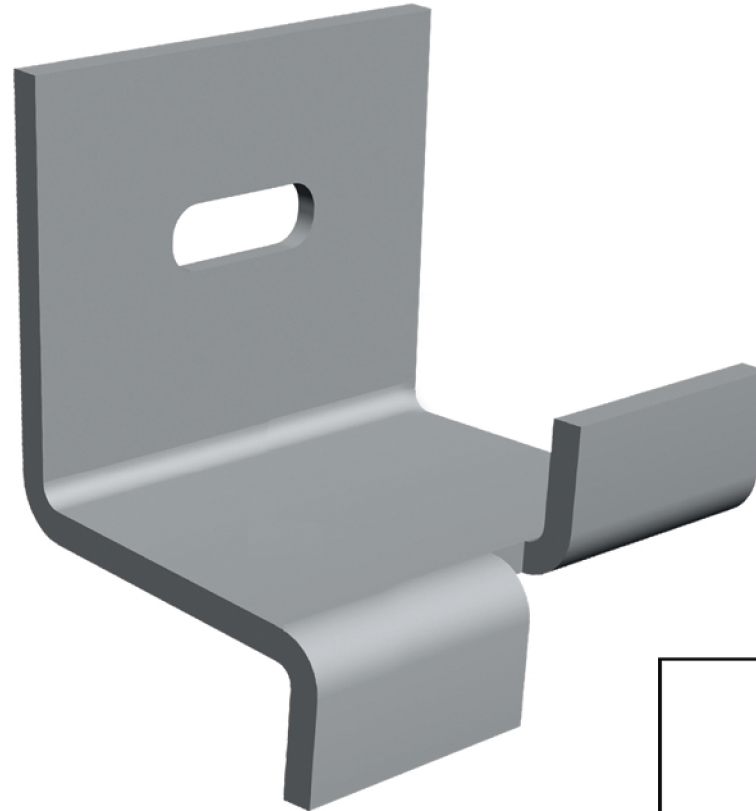
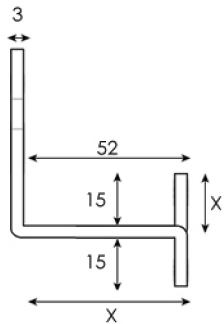

Typology of material A=electrolytic galvanized Steel B=Hot-dip galvanized Steel C=INOX stainless Steel 304 M=Pre-galvanized Steel - Tipologia Materiale A=Acciaio zincato elettrolitico B=Acciaio Zincato a caldo C=Acciaio INOX 304 M=Acciaio Zincato Sendzimir - Materialtypologie A=elektrolitisch verzinkter Stahl B=feuerverzinkter Stahl C=rostfreier Edelstahl 304 M=Zinkstahl Sendzimir  
Dimensions in this catalogue are in millimeters, those with X value can be varied on demand - Le quote espresse nel catalogo sono in mm e quelle con valore X sono variabili a richiesta - Sämtliche Abmessungen im Katalog sind in mm und jene mit X gekennzeichneten können Ihren individuellen Wünschen angepasst werden